



ATW PRECISION TECH. CO., LTD.

PRODUCT NAME

AC TO DC 48V POE ADAPTER

PART NUMBER

ATW-4810P

DOC. NO: SP-TC-0014

AUTHOR : MIKE

DATE: 2014/09/29

REV. : 0

<u>APPROVED</u>	<u>CHECKED</u>
SIGNED:HS.CHEN	SIGNED: YM.XU
DATE: 2014.09.29	DATE: 2014.09.29

CUSTOMER APPROVED SIGNATURE			

CONTENTS

Section	Description
1.0	Scope
2.0	Product Description
3.0	Appearance Inspection Specified And Environmental Test
4.0	Specifications Electrical Valuation And Test Specifications
5.0	Úackaging requirements
6.0	Related Documents and Attachments

1.0 Scope

This document describes mechanical, electrical and environmental test specifications for the adapter using

All tests should, if nothing else is stated, be made on adapter conditioned minimum 24 hours at 20~23°C. with 40~60% RH

2.0 Product Description

2.1 Consumer Benefits

The 4810P Passive Power Over Ethernet (PoE) adapter kit is designed to supply operational power to surveillance cameras and wireless LAN devices such as access points, bridges and routers. It enables power current to travel on the Ethernet network cable, thus eliminates the need to directly connect a power supply to the wireless LAN device. The 4810P supports both 48VDC power requirements.

2.2 Quality Guarantee

2.2.1 The material used in this assembly shall be RoHS compliant. Individual component records shall be maintained by all tier 1 suppliers.

2.2.2 Smart PC board layout improves working efficiency and reduces heat

2.2.3 Every product should be burn-in before delivered to customer.

2.2.4 Safety standards: UL FCC, CE.

2.3 Product Features

2.3.1 The Power Over Ethernet allows you to install the wireless LAN device and surveillance camera at places such as on a building rooftop, on or near a ceiling, or other difficult places where power is not easily accessible. The idea is increase the usefulness of your camera and wireless LAN to provide connectivity to user regardless of their proximity to a power outlet or a network cable.

2.3.2 On a standard UTP Category 5 Cable or Category 6, only two pairs (pins 1, 2, 3, and 6) are used for Ethernet data transfer. Power Over Ethernet is designed to take advantage of the unused pins of the remaining pair of cable wires. Consequently, a single Category 5 or Category 6 cable will now carry both Ethernet data and DC power. The idea is to supply the remote end with power and the requirements of Ethernet connectivity via a single Category 5 or Category 6 cable.

2.3.3 The 4810P includes a base unit and a terminal unit. At one end, the base unit inserts DC voltage into the unused wires (pins 4, 5(+), 7 and 8(-) of the network cable. At the other end, the terminal unit splits the data and DC power. Data signal continue to transmission on network

cables, while Network wire plug into the PoE port of power adapter, after plug the Power cord to an AC power outlet.

2.3.4 4810P has remote reset function. It can reset the customer premise equipment (CPE) connected by RJ-45 cable. (Remote reset CPE device function)

2.3.5 The 4810P is powered on. the LED will remain on the blue.

3.0. Appearance/Dimension Inspection Specified And Environmental Test Specifications

3.1 Appearance: see the drawing

3.2 Color of Case: Black

3.3 MTBF calculation

The power supply shall be designed and produced to have a mean time between failure(MTBF) of 30000 operating hours minimum conditions:
@100VAC-220VAC,0~1A, 0°C~40°C

3.4 High temperature test (Operating)

Full load 40°C, storage 12 hours, then power on/off 5 times at 110-220VAC input, operating 48hours,Normal performance after test condition is removed.

3.5 Low temperature test (Operating)

Full load -20°C, storage 12 hours, then power on/off 5 times at 110-220VAC input, operating 48 hours,Normal performance after test condition is removed.

3.6 High temperature and humidity test (Operating)

+40°C, 90% RH, Load 1A, 110-220VAC input, 24 hours; Normal performance after test condition is removed.

3.7 High temperature and humidity test (Non-operating)

+40°C, 95% RH, 48 hours, tested within 3 minutes in ambient 25°C after take out from chamber; Meet to Dielectric strength and insulation resistance test

3.8 LOW TEMPERATURE STORAGE TEST

The unit shall be subjected to a storage temperature of -20°C for 72 hours.

After test, function OK (in accordance with BS EN 60068-2-1)

3.9 HIGT TEMPERATURE STORAGE TEST

The unit shall be subjected to a storage temperature of +85°C for 72 hours.

After Test, function OK

3.10 Mechanical shock (non-operating, non packing)

Trapezoidal shock, shock level 40G, duration time: 12~25mS, a series of 6 shocks, one on each side After this test item, functions are normal, can be passed dielectric strength and insulation resistance test.

3.11 Drop Testing

Minimum of three samples shall be dropped from a height of 1m onto a concrete surface six times. The adapter case must not crack nor do internal parts become loose. No electrical discontinuities can exist. The adapter must pass all electrical tests after drop testing.

3.12 Construction

The adapter shall be constructed to be durable and safe in the mobile environment. All electronic parts shall be enclosed with a plastic housing to protect against electrical shock.

4.0 ELECTRICAL CHARACTERISTICS

Electrical circuitry shall be manufactured to meet the workmanship requirements of recognized international electrical standards such as IPC 610, 620 or IEC 60204.

4.1 Temperature Requirements

4.1.1 Normal operating temperature range

MIN	MAX
-20°C	40°C

4.1.2 The maximum surface temperature for the adapter board during normal operation

MAX
110°C

4.1.3 Enclosure surface temperature rise: Enclosure temp. Rise<45°C @ Ambient 25°C, 100~240Vac,full load;

MAX
45°C

4.1.4 Operation humidity

10 ~ 95 % RH. NON-CONDENSING

4.1.5 Storage temperature

-20 °C ~ +85 °C

4.1.6 Storage humidity

10 ~ 95 % RH. NON-CONDENSING

4.2 Input Requirements

4.2.1 Input Voltage:

Operating voltage range is (see table). The device must have an internal fuse or positive temperature co-efficient (PTC)

Input Voltage	Frequency Range
AC 100V to 240V	50HZ—63HZ

4.2.2 Input Current:

The TC shall not consume more than (see table) current when output is not connected.

Loading	Input Current
No Load	MAX 60 mA
ON Load	MAX 1100 mA

4.2.3 Input inrush current

AT FULL LOAD, 25°C, COLD START:

Nominal AC input voltage	No damage shall be occurred and the input fuse shall not be blown up.
--------------------------	---

4.2.4 Consumed power

Input nominal AC voltage no load power consumption less than 0.8W.

4.3 Output Voltage

4.3.1 Output voltage shall be the same with no load and at max load (see table).

Loading	Voltage Range
No load	48.0 ± 5%V VDC
1000mA	48.0± 5%V VDC

4.4 Output Ripple

Maximum output ripple is (see table) measured at maximum load and no load.

Loading	Output Voltage Ripple
1000mA	≤ 280 mVp-p
No Load	≤ 280 mVp-p

The maximum load test shall be conducted by connecting an electronic load and an oscilloscope across the output pins of the adapter connector. A 10uF/63V capacitor of choice may be used in the test circuit to match the capacitance of the adapter.

Adjust the electronic load for maximum rated output current of the adapter; measure ripple at two loading conditions, maximum load and at no load; measure ripple at **0°C** and **25°C** at input voltage of **110VAC, 220VAC,**

4.5 Dielectric strength

Primary (LN) to Secondary: 3000VAC 5mA 1 minute; 3000VAC 5mA 2 second for mass product.

5.0 packaging requirements

Individual charger products shall be packaged as follows for shipment from the manufacturing facility to customer, or the adapter packaging according to customer requirements

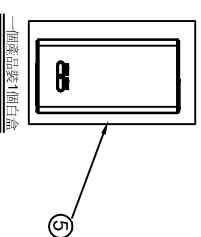
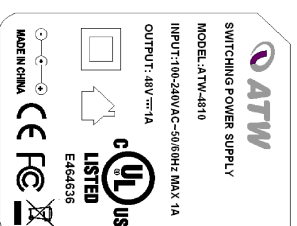
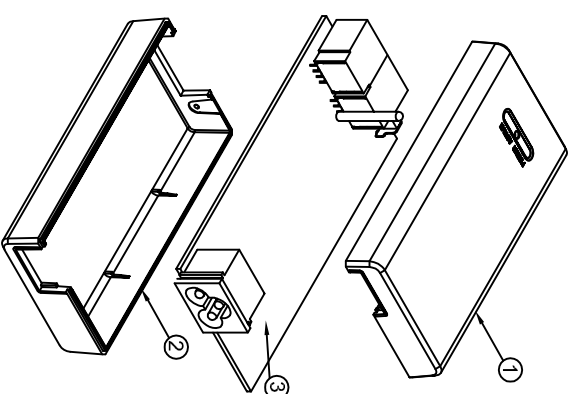
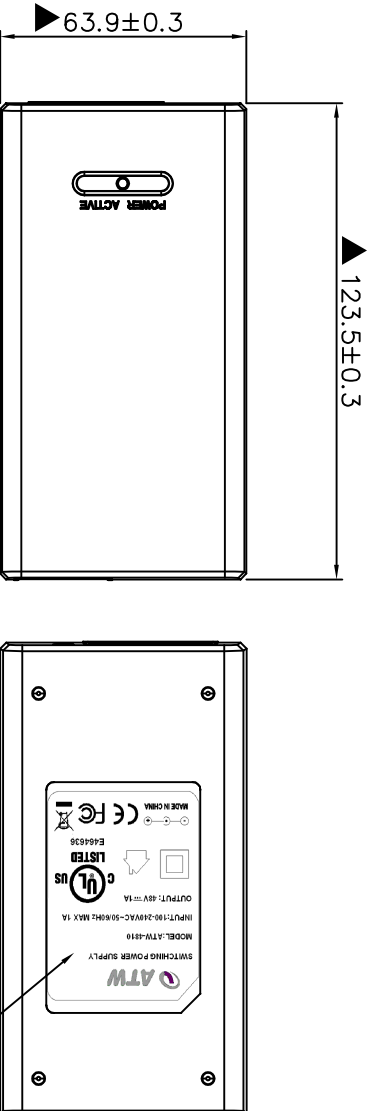
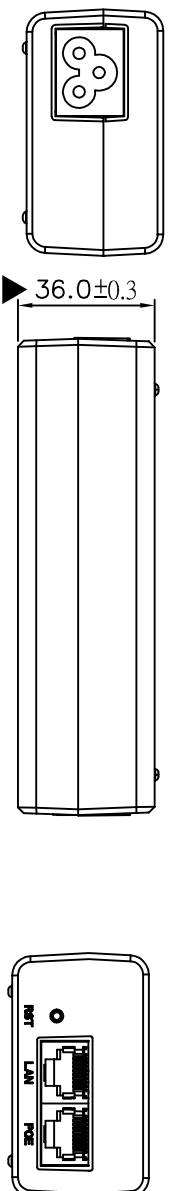

- Special Requirement:**
1. 删除所有毛刺和锐利的边缘
 2. 四周缝隙均匀, 依距地面1m落摔6次不开裂为準.
 3. 小白盒包装 127*65*39.0mm.
 4. INPUT: 100-240V~50/60Hz 1A MAX, OUTPUT: 48V/1000mA
 5. 量試產品需燒機24小時, 每批產品需燒機4小時以上.
 6. 所有材料須符合RoHS標準.
 7. DIMENSIONS MARKED "▲" TO BE CHECKED.

NO	料號	品名	規格	數量
①	G4200-0294	上蓋	BLACK PC945	1PC
②	G4201-0251	下蓋	BLACK PC945	1PC
③	G3100-0550	基板半成品	48V 1A POE POWER	1PC
④	G6108-0893	CE LABEL	59.0*39.0mm	1PC
⑤	G6100-0301	小白盒	127*65*39.0mm	1PC

UNITS: mm	GENERAL TOLERANCE	DR: zhouch	REV. ECN No.	DESCRIPTION	DATE
SCALE: 2 : 1	.X ±0.3 .XX ±0.2 .XXX ±	X° ±2° X° ±1°	▲	試作版	07/22/14
DATE: 07/22/14	MAT'L	CHKD:	▲		
SHEET: 1 OF 1	FINISH	APPD:	▲		
CAD No.	RRV: 0	DWG. No. G12PTR-538-0016	▲		
ATW ATW TECHNOLOGY INC.					

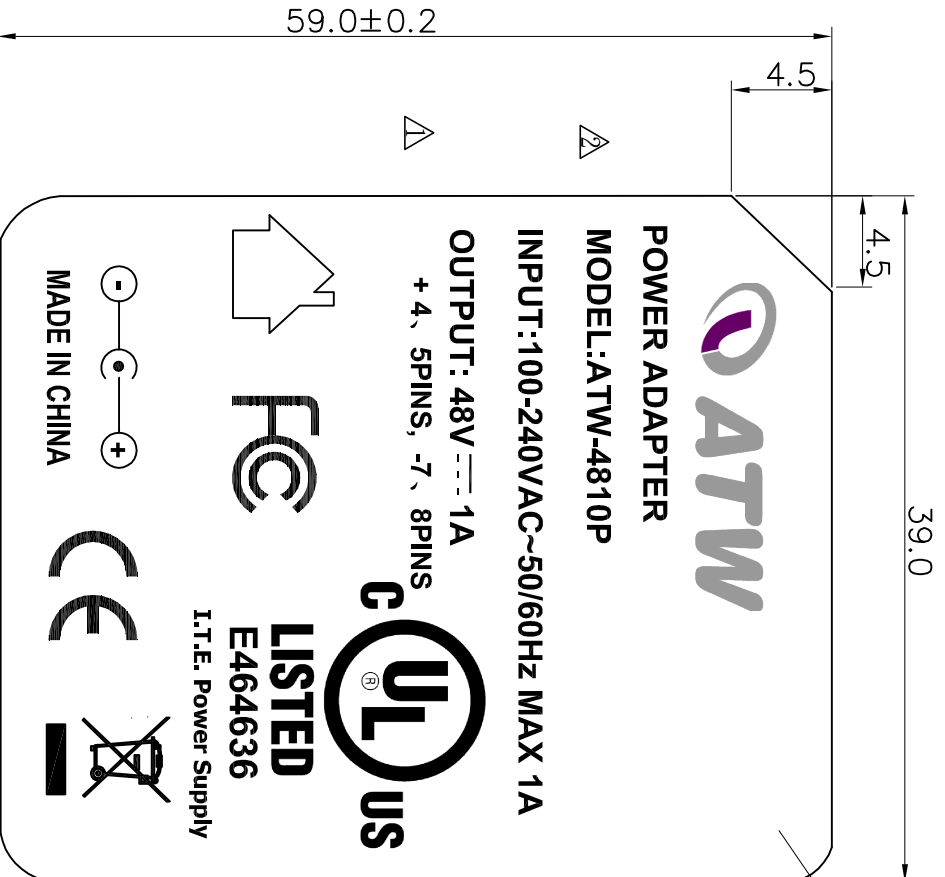

NOTES :

1. 材料:25#消銀特多龍標籤紙(不變色)(UL底),黑底白字
 不低于5.0mm
2. 廠商:大力;材質編號: DL-05; UL 認證號: MH19574.
3. 粘著劑類型:改進型的丙烯酸(壓力敏感型).
 耐溫-25度至+75度.
4. 字體印刷內容要上下左右置中.
5. 膠水要塗滿整面貼紙背面.
6. 符合RoHS標準

REV.	ECN No.	DESCRIPTION	DATE
△		印刷內容變更	10/8/14
△		印刷內容變更	8/7/14
△		試作版	7/22/14

UNITS: mm	GENERAL TOLERANCE	DR: zhouch	PART No. G6108-0893
SCALE: NONE	X ± 0.2 XX ± 0.1 XXX ±	CHD:	TITLE: LP-481P后蓋貼紙 for 48V1A
DATE: 10/8/14	MAF'L	APPD:	DWG. No. G6108-0893
SHEET: 1 OF 1	FINISH	REV: 2	ATW TECHNOLOGY INC.
CAD No.			